

2

1

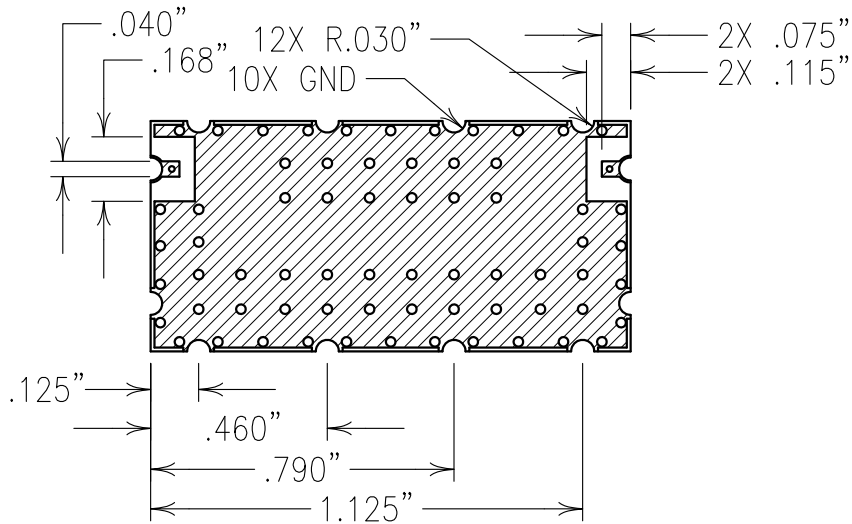
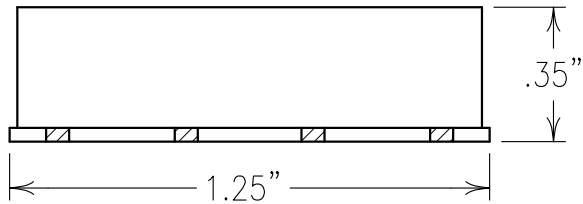
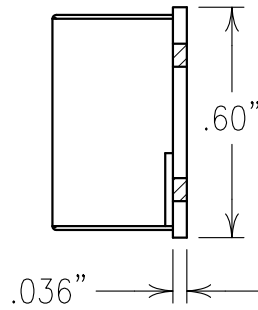
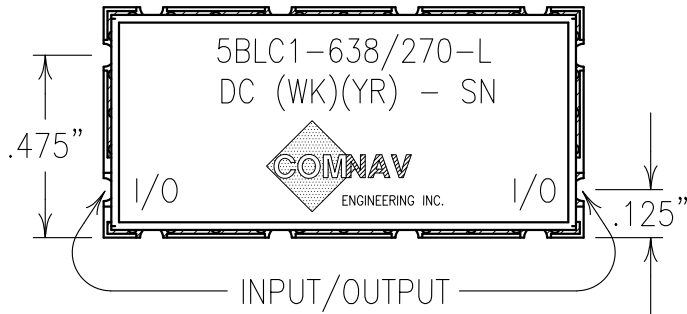

ELECTRICAL CHARACTERISTICS

CENTER FREQUENCY: 638 MHz NOM
PASSBAND: 512-764 MHz
P.B. INSERTION LOSS: 2.2 dB MAX
RETURN LOSS: 14 dB
REJECTION:
40 dBc MIN @ DC-400 MHz
40 dBc MIN @ 970-4000 MHz
SOURCE AND LOAD: 50 OHMS

COPY

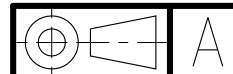

Confidential and Proprietary information of ComNav Engineering Inc. Do Not Duplicate or Use Without Permission. ComNav Engineering Inc. claims Copyright in this document as of the Creation, last revision, and last updated dates. All Rights Reserved.

ENGLISH / METRIC ENGLISH	CHECKED BY				
TOLERANCES UNLESS OTHERWISE SPECIFIED TO BE 125/100 OR BETTER REMOVE ALL BURRS	DRAWN BY PBF	II	01OCT15	KJR	DEV. INI. ISS. PER 3956
	ENGINEER KJR	REV	DATE	BY	DCN No. REMARKS

ENGLISH (INCHES) .XX ±.02 .XXX ±.010	METRIC (MM) .X ±.50 .XX ±.25	SCALE 2:1	APPLIC: CHIP AND WIRE FILTER
ANGLES ± 0° 30'	DATE 09OCT15	TITLE: 5BLC1-638/270-L	

NOTES:

FILTER IS ROHS COMPLIANT.



FINISH: BOARD: NICKEL/GOLD
JACKET: NICKEL/SILVER

DRAWING No.
0L1536

SHEET OF
1 1